

Tavola riassuntiva delle principali caratteristiche costruttive e di funzionamento Main fabrication and operating characteristics table

Mod.	Tipi di cappello	Certificati	Conessioni
241	Mezzo bocchaglio	Chiuso	PED-ATEX-RINA-
241b	Bocchaglio pieno	(molla coperta)	G.L.-GOST- B.V.
242	Mezzo bocchaglio	Aperto	PED - GOST
242b	Bocchaglio pieno	(molla scoperta)	
241F	Mezzo bocchaglio	Chiuso	PED-ATEX-RINA
241bF	Bocchaglio pieno	(molla coperta)	G.L.-GOST-B.V.
242F	Mezzo bocchaglio	Aperto	PED - GOST
242bF	Bocchaglio pieno	(molla scoperta)	

Type	Bonnet type	Certifications	Connections
241	Semi nozzle	Closed	PED-ATEX-RINA
241b	Full nozzle	(covered spring)	G.L.-GOST-B.V.
242	Semi nozzle	Open	PED - GOST
242b	Full nozzle	(uncovered spring)	
241F	Semi nozzle	Closed	PED-ATEX-RINA
241bF	Full nozzle	(covered spring)	G.L.-GOST-B.V.
242F	Semi nozzle	Open	PED - GOST
242bF	Full nozzle	(uncovered spring)	

Principali caratteristiche di funzionamento

Applicazioni	Aeriformi	Liquidi
Intervallo pressioni di taratura p:	da 0.2 a 40 bar	da 0.2 a 40 bar

Materiali di costruzione di corpo e cappello	Interv. temp. di esercizio*
Corpo e cappello in ghisa	da -10 a +300°C
Corpo in acciaio al carbonio e cappello aperto in ghisa	da -10 a +400°C
Corpo in acciaio al carbonio e cappello chiuso in ghisa	da -10 a +350°C
Corpo e cappello in acciaio al carbonio	da -20 a +425°C
Corpo e cappello in acciaio inossidabile	da -196 a +537°C

* Per temperature e pressioni diverse da quelle riportate nella presente tabella, fare riferimento all'Ufficio Tecnico.

Coefficienti di efflusso	Aeriformi	Liquidi
Kd (certificato)	0.81	0.55
Kdr (Kd • 0.9) (ridotto)	0.73	0.50

	Aeriformi	Liquidi
Sovrapressione	+5% se p ≥ 3 bar +10% se 1 ≤ p < 3 bar +0.1 bar se p < 1 bar	+10% di p + 0.1 bar se p > 1 bar
Scarto di chiusura	-10% di p - 0.1 bar se p < 1 bar	-20% di p - 0.2 bar se p < 1 bar

Massima contropressione generata ammessa pb***

Valvola senza soffiato di bilanciamento	15% della pressione di taratura (aeriformi) 20% della pressione di taratura (liquidi)
Valvola con soffiato di bilanciamento	40% della pressione di taratura

*** Nel caso di contropressione imposta fare riferimento all'Ufficio Tecnico.

Classificazione corpi

Materiale corpo	Esecuzioni flangiate		Esecuzioni filettate	
	Entrata	Uscita	Entrata	Uscita
Ghisa	EN PN 16 EN PN 25 ASME CL 150	EN PN 16 ASME CL 150	PN 25	PN 16
Acciaio	EN PN 16-EN PN25 EN PN 40 ASME CL 150 ASME CL 300	EN PN 16 ASME CL 150	CL 300	CL 150

LEGENDA: p= pressione di taratura (barg); pb= contropressione (barg).

Note

Per limiti di impiego differenti da quelli indicati nella presente tavola, fare riferimento all'Ufficio Tecnico.

Valvole di sfioro

Le valvole della serie 240 sono disponibili anche nella versione valvole di sfioro. Le Valvole di sfioro, identificate dalla lettera R posta accanto al numero identificante il modello, si caratterizzano come accessori (dispositivi) a pressione aventi funzione di servizio. I materiali di costruzione, le dimensioni ed i limiti di utilizzo secondo il rapporto pressione/temperatura delle valvole di sfioro, sono gli stessi validi per le valvole di sicurezza della Serie 240.

Alcuni dati riportati nella presente pagina possono variare su specifica richiesta, previa analisi e approvazione delle funzioni competenti di Besa S.p.A.

Main operating characteristics

Applications	Gaseous	Liquid
Set pressure range p:	from 0.2 to 40 bar	from 0.5 to 40 bar

Body and bonnet construction material	Temperature Range*
Cast iron body and bonnet	from -10 to +300°C
Carbon steel body and cast iron open bonnet	from -10 to +400°C
Carbon steel body cast iron closed bonnet	from -10 to +350°C
Carbon steel body and bonnet	from -20 to +425°C
Stainless steel body and bonnet	from -196 to +537°C

* For temperature and pressure different than those in this table, ask to Technical Department.

Coefficient of discharge	Gaseous	Liquid
Kd (certified)	0.81	0.55
Kdr (Kd • 0.9) (derated)	0.73	0.50

	Gaseous	Liquid
Overpressure	+5% if p ≥ 3 bar +10% if 1 ≤ p < 3 bar +0.1 bar if p < 1 bar	+10% of p + 0.1 bar if p > 1 bar
Blow down	-10% of p - 0.1 bar if p < 1 bar	-20% of p - 0.2 bar if p < 1 bar

Maximum allowable built up back pressure pb***

Safety valves without balancing bellow	15% of set pressure (gas and vapour) 20% of set pressure (liquid)
Safety valves with balancing bellow	40% of set pressure

*** In case of superimposed backpressure, please refer to Technical Department.

Body Ratings

Body material	Flanged valves		Threaded valves	
	Inlet	Outlet	Inlet	Outlet
Cast iron	EN PN 16 EN PN 25 ASME CL 150	EN PN 16 ASME CL 150	PN 25	PN 16
Cast steel	EN PN 16-EN PN25 EN PN 40 ASME CL 150 ASME CL 300	EN PN 16 ASME CL 150	CL 300	CL 150

LEGENDA: p=set pressure (barg) pb= backpressure (barg)

Note

For operating range different than those in this table please refer to Technical Dept.

Relief Valves

240 Series Safety valves are also available as Relief valves. Relief valves, identified by the letter R after the type number, are devices with an operational function, having pressure-bearing housings. Materials, dimensions and application limits depending on Pressure/Temperature ratio for Relief Valves are the same of Safety Valves 240 Series.

Some information given on these pages can be changed upon specific requests, after BESA qualified office approval.

Tavola riassuntiva delle principali caratteristiche costruttive e di funzionamento Main fabrication and operating characteristics table

241 T

Modello	Descrizione	Tipo di cappello	Certificati	Connessioni
241 T	Mezzo boccaglio - corpo valvola rivestito in materiale termoplastico e soffietto di bilanciamento/ protezione in PTFE	Cappello chiuso (molla coperta)	PED ATEX GOST	Connessioni std. Flangiate EN o ANSI (per esecuzioni diverse, fare riferimento all'Ufficio Tecnico)

Materiali di rivestimento previsti per il modello 241T: PFA, PVDF, ETFE, HALAR. (spessore del rivestimento 0,8 mm)

241 bT

Modello	Descrizione	Tipo di cappello	Certificati	Connessioni
241 bT	Corpo valvola con boccaglio pieno e soffietto di bilanciamento / protezione in PTFE	Cappello chiuso (molla coperta)	PED ATEX GOST	Connessioni std. flangiate EN (PN 16-25-40) o ANSI (CL 300 e 300) Esecuzioni diverse su specifica richiesta.

241 T

Type	Description	Bonnet type	Certification	Connections
241 T	Semi nozzle Valve body lined with thermoplastic material and balancing/isolating bellow in PTFE	Closed bonnet (covered spring)	PED ATEX GOST	Flanged connections. According to EN or ANSI (for different executions please refer to Technical Dept.)

Lining materials available for Type 241T: PFA, PVDF, ETFE, HALAR. (lining thickness 0,8 mm)

241 bT

Type	Description	Bonnet type	Certification	Connections
241 bT	Valve body with PTFE full nozzle and isolating/balancing bellow	Closed bonnet (covered spring)	PED ATEX GOST	Flanged connections EN (PN 16-25-40) o ANSI (CL 150 e 300). Different execution upon request.

Principali caratteristiche di funzionamento

Modello	Campo di applic.	Aeriformi	Liquidi	Interv. temp. di esercizio
241 T	Campo pressioni di taratura p	da 0.2 a 10 bar	da 0.2 a 10 bar	
241 bT	Campo pressioni di taratura p	da 0.2 a 16 bar	da 0.2 a 16 bar	
241 T	Corpo in acciaio rivestito in materiale termoplastico			da -20 a +150°C (vapore e gas) da -20 a +100°C (liq.)
241 bT-C	Corpo in acciaio al carbonio con boccaglio in PTFE			da -20 a +200°C
241 bT-I	Corpo in acciaio inossidabile con boccaglio in PTFE			da -196 a +200°C
Coefficiente di efflusso Kd certificato	0.81	0.55		
Coeff. di efflusso ridotto Kdr (kd•0.9)	0.73	0.50		
Sovrapressione	+5% se p>3 bar +10% se 1≤p<3 bar +0.1 bar se p<1 bar	+10% di p +0.1 bar se p> 1 bar		
Scarto di chiusura	-10% di p - 0.1 bar se p < 1 bar	-20% di p - 0.2 bar se p < 1 bar		
Max contropressione generata ammessa pb				
Valvola senza soffietto di bilanciamento	35% della pressione di taratura (generata)			

LEGENDA: p= pressione di taratura (barg); pb= contropressione (barg).

Note

L'idoneità all'esercizio del materiale di rivestimento, deve essere valutata in relazione alle seguenti condizioni: natura e stato fisico del fluido di processo; pressione e temperatura di esercizio.

Valvole di sfioro

Le valvole della serie 240 sono disponibili anche nella versione valvole di sfioro. Le Valvole di sfioro, identificate dalla lettera R posta accanto al numero identificante il modello, si caratterizzano come accessori (dispositivi) a pressione aventi funzione di servizio. I materiali di costruzione, le dimensioni ed i limiti di utilizzo secondo il rapporto pressione/temperatura delle valvole di sfioro, sono gli stessi validi per le valvole di sicurezza della Serie 240.

Alcuni dati riportati nella presente pagina possono variare su specifica richiesta, previa analisi e approvazione delle funzioni competenti di Besa S.p.A.

Main operating characteristics

Type	Applications	Gaseous	Liquid	Temperature range
241 T	Set pressure range p	from 0.2 up to 10 bar	from 0.2 up to 10 bar	
241 bT	Set pressure range p	from 0.2 up to 16 bar	from 0.2 up to 16 bar	
241 T	Cast steel body lined with thermoplastic material			from -20 up to +150°C (vapour and gas)
				from -20 up to +100°C
241 bT-C	Carbon steel body with PTFE nozzle			from -20 up to +200°C
241 bT-I	Stainless steel body with PTFE nozzle			from -196 up to +200°C
Certified coefficient of discharge Kd	0.81	0.55		
Derated coefficient of discharge Kdr (kd•0.9)	0.73	0.50		
Overpressure	+5% if p>3 bar +10% if 1≤p<3 bar +0.1 bar if p<1 bar	+10% of p +0.1 bar if p> 1 bar		
blow down	-10% of p - 0.1 bar if p < 1 bar	-20% of p - 0.2 bar if p < 1 bar		
Max. allowable back pressure pb				
Safety valves without balancing bellow	35% of set pressure (built up)			

LEGENDA: p=set pressure (barg) pb= backpressure (barg)

Note

Lining material suitability to operating conditions, shall be verified considering: kind and physical state of process medium, operating pressure and temperature.

Relief Valves

240 Series Safety valves are also available as Relief valves. Relief valves, identified by the letter R after the type number, are devices with an operational function, having pressure-bearing housings. Materials, dimensions and application limits depending on Pressure/Temperature ratio for Relief Valves are the same of Safety Valves 240 Series.

Some information given on these pages can be changed upon specific requests, after BESA qualified office approval.

Valvole di sicurezza Modello 241-242

Safety Valves Type 241-242

Legenda materiali std.

Descrizione	241-G / 242-G Valvola con corpo in ghisa	241-C / 242-C Valvola con corpo in acciaio al carbonio	241-I Valvola con corpo in acciaio inossidabile
1 Corpo Valvola	Ghisa GS250	Acciaio al Carbonio ASTM A216 WCB - EN 1.0619	Acciaio inossidabile ASTM A351 CF8M - EN 1.4408
2 Sede	Acciaio inossidabile ASTM 316 - EN 1.4401	Acciaio inossidabile ASTM 316 - EN 1.4401	Acciaio inossidabile ASTM 316 - EN 1.4401
3 Otturatore	Acciaio inossidabile ASTM 420 - EN 1.4028	Acciaio inossidabile ASTM 420 - EN 1.4028	Acciaio inossidabile ASTM 316 - EN 1.4001
4 Sfera	Acciaio inossidabile ASTM 420 - EN 1.4028	Acciaio inossidabile ASTM 420 - EN 1.4028	Acciaio inossidabile ASTM 316 - EN 1.4401
5 Piattello Guida	Ghisa GS450/10 con bussola ASTM 430F Tenifer	Ghisa GS450/10 con bussola ASTM 430F Tenifer o acciaio inossidabile ASTM 316 - EN 1.4401	Acciaio inossidabile ASTM 316 - EN 1.4401
6 Ralla Molla	Acciaio AVP	Acciaio AVP	Acciaio inossidabile ASTM 316 - EN 1.4401
7 Asta	Acciaio inossidabile ASTM 430F - EN 1.4104	Acciaio inossidabile ASTM 430F - EN 1.4104	Acciaio inossidabile ASTM 316 - EN 1.4401
8 Molla	Acciaio al carbonio Acciaio legato	Acciaio al carbonio Acciaio legato	Acciaio inossidabile ASTM 316 S42
9 Vite di regolazione	Ottone OT58/AVP	Ottone OT58/AVP	Acciaio inossidabile ASTM 316 - EN 1.4401 con bussola in PTFE
10 Cappello	Ghisa GS450/10	Ghisa o Carbonio ASTM A216 WCB - EN 1.0619	Acciaio inossidabile ASTM A351 CF8M - EN 1.4408
11 Cappuccio H4 a tenuta con leva	Ghisa GS450/10	Ghisa GS450/10	Acciaio inossidabile ASTM A351 CF8M - EN 1.4408

Dimensioni caratterizzanti le prestazioni fluidodinamiche

DN E Entrata	do diametro geometrico orifizio	Area geometrica di efflusso cm ²	DN U Uscita	Alzata otturatore mm	Max pressione di taratura corpo valvola	
					Ghisa barg	Acciaio
20-3/4	18	2.54	40-1"1/2	5.5	25	40
25-1"	23	4.15	40-1"1/2	6.9	25	40
32-1"1/4	29	6.61	50-2"	7.5	25	40
40-1"1/2	37	70.75	65-2"1/2	10.2	25	40
50-2"	46	16.62	80-3"	13.5	25	40
65-2"1/2	60	28.27	100-4"	17.0	25	40
80-3"	74	43.00	125-5"	21.5	25	40
100-4"	92	66.48	150-6"	27.6	25	40
125-5"	98	75.43	200-8"	29.4	25	30
150-6"	125	122.72	250-10"	37.5	25	30
200-8"	165	213.82	350-14"	48	/	30
250-10"	200	314.16	400-16"	58	/	20

Dimensioni scartamenti (mm)

DN E	241-G / 242-G				241-C / 242-C / 241-I				H
	FLANGE EN PN16/PN16 PN25/PN16	FLANGE ANSI/ASME CL150/CL150	FLANGE EN PN16/PN16 PN25/PN16 PN40/PN16	FLANGE ANSI/ASME CL150/CL150 CL300/CL150	A	B	A	B	
20	95	85	94.5	79.7	95	85	94.5	82.9	215
25	100	107	99.5	103.3	100	105	99.5	104.5	265
32	110	115	109	110.9	110	115	109	116	330
40	115	142	117.2	139.5	117	140	117.2	142.6	375
50	120	152	121.3	149.0	120	150	121.3	151.2	420
65	140	170	139.8	168.2	136	172	139.8	175.4	525
80	160	195	157.8	172.8	173	197	157.8	201.6	600
100	180	222	179.4	217.8	188	220	179.4	227.7	655
125	204	250	202.6	243.8	198	246	202.6	254.9	655
150	225	294	223.2	285.4	216	288	223.2	296.5	780
200					345	350	349.9	357.3	1161
250					454	450	459.5	459.6	1161

dimensioni indicative, da confermare in caso di ordine

Cappucci

Cappuccio H4, a tenuta con leva di sollevamento dell'otturatore

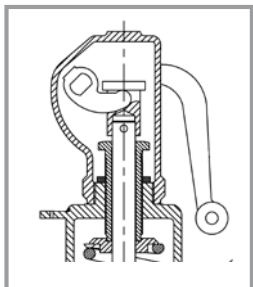

Cappuccio tipo H3, aperto con leva di sollevamento dell'otturatore

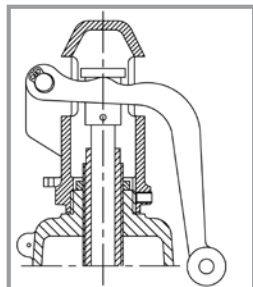

Cappuccio tipo H2, a tenuta senza leva di sollevamento

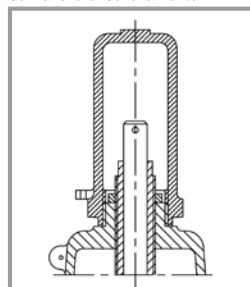

Note

A richiesta e con l'approvazione dell'Ufficio Tecnico, la costruzione delle valvole può essere eseguita utilizzando componenti di materiale diverso da quello indicato nella tabella soprastante.

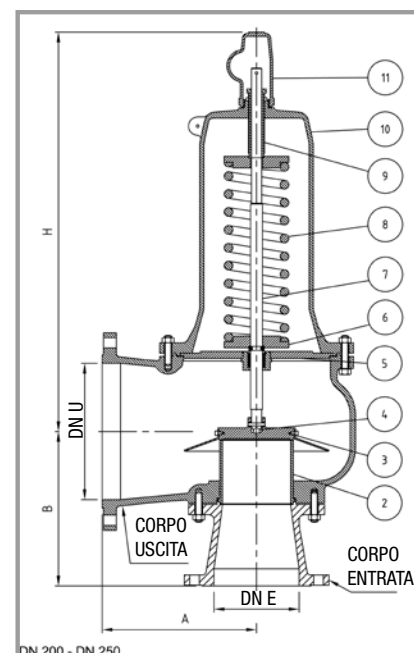
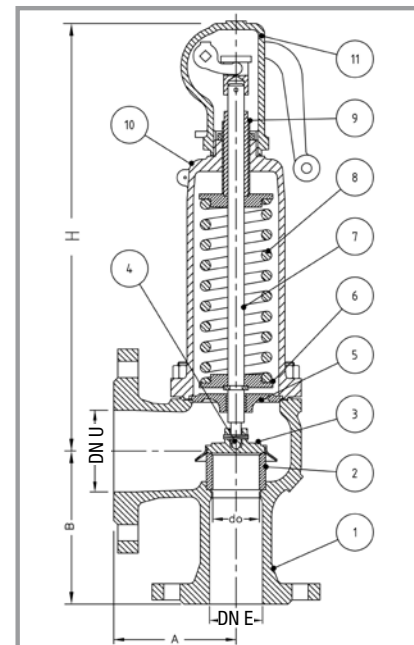

Valvole di sicurezza Modello 241-242
Safety Valves Type 241-242

Std. material legenda

Description	241-G / 242-G Valve with cast iron body	241-C / 242-C Valve with carbon steel body	241-I Valve with stainless steel body
1 Valve body	Cast iron G250	Carbon steel ASTM A216 WCB - EN 1.0619	Stainless steel ASTM A351 CF8M - EN 1.4408
2 Seat	Stainless steel ASTM 316 - EN 1.4401	Stainless steel ASTM 316 - EN 1.4401	Stainless steel ASTM 316 - EN 1.4401
3 Disc	Stainless steel ASTM 420 - EN 1.4028	Stainless steel ASTM 420 - EN 1.4028	Stainless steel ASTM 316 - EN 1.4028
4 Ball	Stainless steel ASTM 420 - EN 1.4028	Stainless steel ASTM 420 - EN 1.4028	Stainless steel ASTM 316 - EN 1.4401
5 Guide	Cast iron Gs450/10 with Bush ASTM 430 F Tenifer	Cast iron Gs450/10 with Bush in ASTM 430F Tenifer or Stainless steel ASTM 316 - EN 1.4401	Stainless steel ASTM 316 - EN 1.4401
6 Spring plate	AVP steel	AVP steel	Stainless steel ASTM 316 - EN 1.4401
7 Spindle	Stainless steel ASTM 430F - EN 1.4104	Stainless steel ASTM 430F - EN 1.4104	Stainless steel ASTM 316 - EN 1.4401
8 Spring	Carbon steel Alloy steel	Carbon steel Alloy steel	Stainless steel ASTM 316 S42
9 Pressure adjusting screw	Brass OT58/AVP steel	Brass OT58/AVP steel	Stainless steel with Bush ASTM 316 EN 1.4401 IN PTFE
10 Bonnet	Cast iron GS450/10	Cast iron GS450/10 or Carbon steel ASTM A216 WCB - EN 1.0619	Stainless steel ASTM A351 CF8M - EN 1.4408
11 Tight cap H4 with lifting lever	Cast iron GS450/10	Cast iron GS450/10	Stainless steel ASTM A351 CF8M - EN 1.4408

Dimensions defining valve performances

DN I Inlet	Actual orifice diameter	Actual discharge area	DN O Outlet	Disc lift	Max set pressure	Cast iron barg	Steel
	mm	cm ²		mm.			
20-3/4	18	2.54	40-1"1/2	5.5	25	40	
25-1"	23	4.15	40-1"1/2	6.9	25	40	
32-1"1/4	29	6.61	50-2"	7.5	25	40	
40-1"1/2	37	70.75	65-2"1/2	10.2	25	40	
50-2"	46	16.62	80-3"	13.5	25	40	
65-2"1/2	60	28.27	100-4"	17.0	25	40	
80-3"	74	43.00	125-5"	21.5	25	40	
100-4"	92	66.48	150-6"	27.6	25	40	
125-5"	98	75.43	200-8"	29.4	25	30	
150-6"	125	122,72	250-10"	37.5	25	30	
200-8"	165	213.82	350-14"	48	/	30	
250-10"	200	314.16	400-16"	58	/	20	

Center to face dimensions (mm)

DN I	241-G / 242-G				241-C / 242-C / 241-I				H
	EN FLANGE PN16/PN16	ANSI/ASME FLANGE CL150/CL150	EN FLANGE PN16/PN16	ANSI/ASME FLANGE CL150/CL150	EN FLANGE PN25/PN16	ANSI/ASME FLANGE CL300/CL150	EN FLANGE PN40/PN16	ANSI/ASME FLANGE CL300/CL150	
20	95	85	94.5	79.7	95	85	94.5	82.9	215
25	100	107	99.5	103.3	100	105	99.5	104.5	265
32	110	115	109	110.9	110	115	109	116	330
40	115	142	117.2	139.5	117	140	117.2	142.6	375
50	120	152	121.3	149.0	120	150	121.3	151.2	420
65	140	170	139.8	168.2	136	172	139.8	175.4	525
80	160	195	157.8	172.8	173	197	157.8	201.6	600
100	180	222	179.4	217.8	188	220	179.4	227.7	655
125	204	250	202.6	243.8	198	246	202.6	254.9	655
150	225	294	223.2	285.4	216	288	223.2	296.5	780
200					345	350	349.9	357.3	1161
250					454	450	459.5	459.6	1161

approximate dimensions to be confirmed at order

Caps

Tight Cap H4 with packed lifting lever

Open Cap H3 with plain lifting lever

Tight Cap H2 without lifting lever

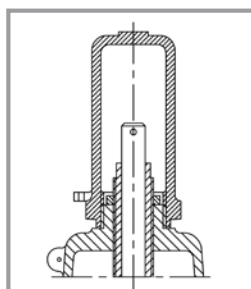
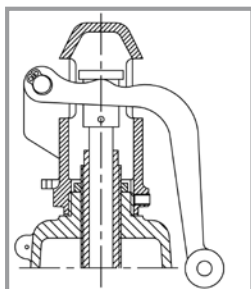
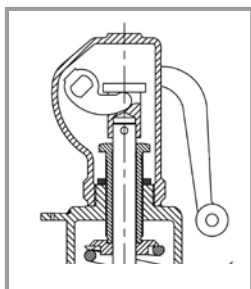

Note

Valves can be manufactured with materials different than those in this table upon request and after Besa Technical Dept. approval.

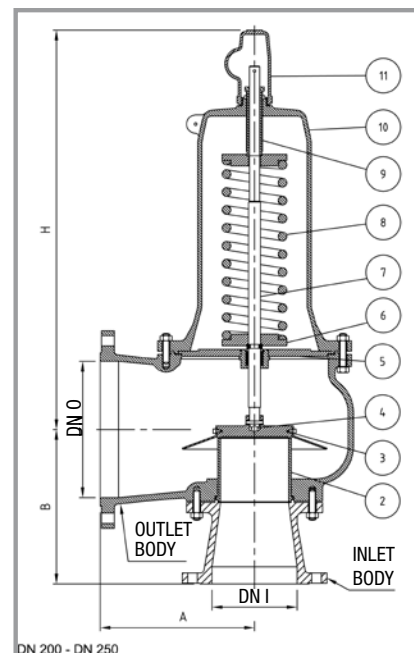
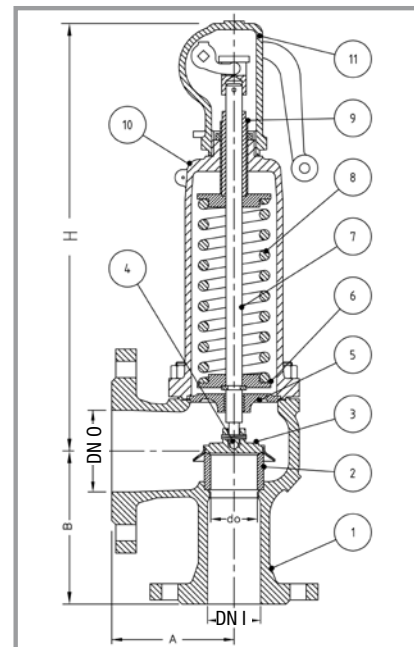

Valvole di sicurezza Modello 241b-242b

Safety Valves Type 241b-242b

Legenda materiali std.

Descrizione	241b-C / 242b-C Valvola con corpo in acciaio al carbonio	241b-I Valvola con corpo in acciaio inossidabile
1 Corpo Valvola	Acciaio al carbonio ASTM A216 WCB - EN 1.0619	Acciaio inossidabile ASTM A351 CF8M - EN 1.4408
2 Boccaglio	Acciaio inossidabile ASTM 316 - EN 1.4401	Acciaio inossidabile ASTM 316 - EN 1.4401
3 Otturatore	Acciaio inossidabile ASTM 420 - EN 1.4028	Acciaio inossidabile ASTM 316 - EN 1.4401
4 Sfera	Acciaio inossidabile ASTM 420 - EN 1.4028	Acciaio inossidabile ASTM 316 - EN 1.4401
5 Piattello Guida	Ghisa GS450/10 Con bussola ASTM 430F Tenifer o acciaio inossidabile ASTM 316 - EN 1.4401	Acciaio inossidabile ASTM 316 - EN 1.4401
6 Ralla Molla	Acciaio AVP	Acciaio inossidabile ASTM 316 - EN 1.4401
7 Asta	Acciaio inossidabile ASTM 430F - EN 1.4104	Acciaio inossidabile ASTM 316 - EN 1.4401
8 Molla	Acciaio al carbonio Acciaio legato	Acciaio inossidabile ASTM 316 S42
9 Vite di regolazione	Ottone OT58 / Acciaio AVP	Acciaio inossidabile ASTM 316 - EN 1.4401 / con bussola in PTFE
10 Cappello	Ghisa GS 450/10 o acciaio al carbonio ASTM A216 WCB - EN 1.0619	Acciaio inossidabile ASTM A351 CF8M - EN 1.4408
11 Cappuccio H4 a tenuta con leva	Ghisa GS 450/10	Acciaio inossidabile ASTM A351 CF8M - EN 1.4408

Dimensioni caratterizzanti le prestazioni fluidodinamiche

DN E Entrata	do diametro geometrico orifizio mm	Area geometrica di efflusso cm ²	DN U Uscita	Alzata otturatore mm	Max pressione di taratura barg
20-3/4"	18	2.54	40-1"1/2	5.5	40
25-1"	23	4.15	40-1"1/2	6.9	40
32-1"1/4	29	6.61	50-2"	7.5	40
40-1"1/2	37	10.75	65-2"1/2	10.2	40
50-2"	46	16.62	80-3"	13.5	40
65-2"1/2	60	28.27	100-4"	17.0	40
80-3"	74	43.00	125-5"	21.5	40
100-4"	92	66.48	150-6"	27.6	40
125-5"	98	75.43	200-8"	29.4	30
150-6"	125	122.72	250-10"	37.5	30
200-8"	165	213.82	350-14"	48	30
250-10"	200	314.16	400-16"	58	20

Dimensioni scartamenti (mm)

241b-C / 242b-C / 241b-I

FLANGE EN	FLANGE
PN16/PN16	ANSI/ASME
PN25/PN16	CL150/CL150
PN40/PN16	CL 300/CL150

DN E	A	B	A	B	H
20	95	85	94.5	82.9	215
25	100	105	99.5	104.5	265
32	110	115	109	116	330
40	170	140	117.2	142.6	375
50	120	150	121.3	151.2	420
65	136	172	139.8	175.4	525
80	173	197	157.8	201.6	600
100	188	220	179.4	227.7	655
125	198	246	202.6	254.9	655
150	216	288	223.2	296.5	780
200	345	350	349.9	357.3	1161
250	454	450	459.5	459.6	1161

dimensioni indicative, da confermare in caso di ordine

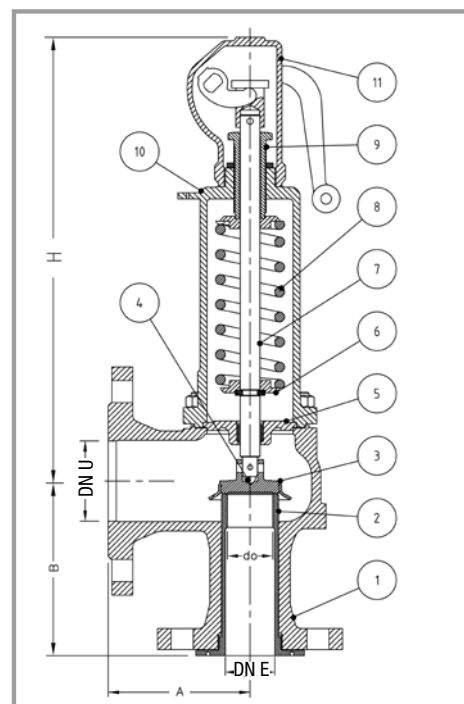

Cappucci

Cappuccio a tenuta con leva di sollevamento dell'otturatore H4

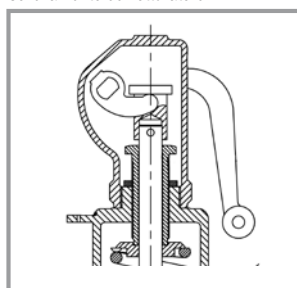

Cappuccio aperto tipo H3 con leva di sollevamento dell'otturatore

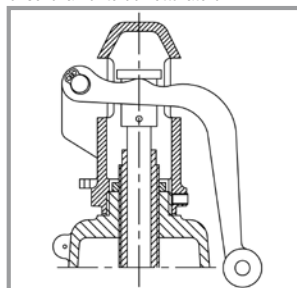

Cappuccio a tenuta tipo H2 senza leva di sollevamento

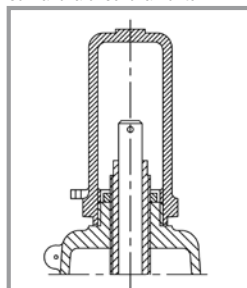

Note

A richiesta e con l'approvazione dell'Ufficio Tecnico, la costruzione delle valvole può essere eseguita utilizzando componenti di materiale diverso da quello indicato nella tabella soprastante.

Valvole di sicurezza Modello 241b-242b
Safety Valves Type 241b-242b

Std. material legenda

Description	241b-C / 242b-C Valve with carbon steel body	241b-1 Valve with stainless steel body
1 Valve body	Carbon steel ASTM A216 WCB - EN 1.0619	Stainless steel ASTM A351 CF8M - EN 1.4408
2 Full nozzle (seat)	Stainless steel ASTM 316 - EN 1.4401	Stainless steel ASTM 316 - EN 1.4401
3 Disc	Stainless steel ASTM 420 - EN 1.4028	Stainless steel ASTM 316 - EN 1.4401
4 Ball	Stainless steel ASTM 420 - EN 1.4028	Stainless steel ASTM 316 - EN 1.4401
5 Guide	Cast iron GS450/10 with Bush in ASTM 430F Tenifer or Stainless steel ASTM 316 - EN 1.4401	Stainless steel ASTM 316 - EN 1.4401
6 Spring plate	AVP steel	Stainless steel ASTM 316 - EN 1.4401
7 Spindle	Stainless steel ASTM 430F - EN 1.4104	Stainless steel ASTM 316 - EN 1.4401
8 Spring	Carbon steel Alloy steel	Stainless steel ASTM 316 S42
9 Pressure adjusting screw	Brass OT58 / AVP steel	Stainless steel ASTM 316 - EN 1.4401 / with Bush in PTFE
10 Bonnet	Cast iron GS 450/01 or Carbon steel ASTM A216 WCB - EN 1.0619	Stainless steel ASTM A351 CF8M - EN 1.4408
11 Tight cap H4 with lifting lever	Cast iron GS 450/10	Stainless steel ASTM A351 CF8M - EN 1.4408

Dimensions defining valve performances

DN I Inlet	Actual orifice diameter mm	Actual discharge area cm ²	DN O Outlet	Disc lift mm.	Max set pressure barg
20-3/4"	18	2.54	40-1"1/2	5.5	40
25-1"	23	4.15	40-1"1/2	6.9	40
32-1"1/4	29	6.61	50-2"	7.5	40
40-1"1/2	37	10.75	65-2"1/2	10.2	40
50-2"	46	16.62	80-3"	13.5	40
65-2"1/2	60	28.27	100-4"	17.0	40
80-3"	74	43.00	125-5"	21.5	40
100-4"	92	66.48	150-6"	27.6	40
125-5"	98	75.43	200-8"	29.4	30
150-6"	125	122.72	250-10"	37.5	30
200-8"	165	213.82	350-14"	48	30
250-10"	200	314.16	400-16"	58	20

Center to face dimensions (mm)

241b-C / 242b-C / 241b-1

EN FLANGE	ANSI/ASME FLANGE
PN16/PN16	CL150/CL150
PN25/PN16	CL 300/CL150
PN40/PN16	

DN I	A	B	A	B	H
20	95	85	94.5	82.9	215
25	100	105	99.5	104.5	265
32	110	115	109	116	330
40	170	140	117.2	142.6	375
50	120	150	121.3	151.2	420
65	136	172	139.8	175.4	525
80	173	197	157.8	201.6	600
100	188	220	179.4	227.7	655
125	198	246	202.6	254.9	665
150	216	288	223.2	296.5	780
200	345	350	349.9	357.3	1161
250	454	450	459.5	459.6	1161

approximate dimensions to be confirmed at order

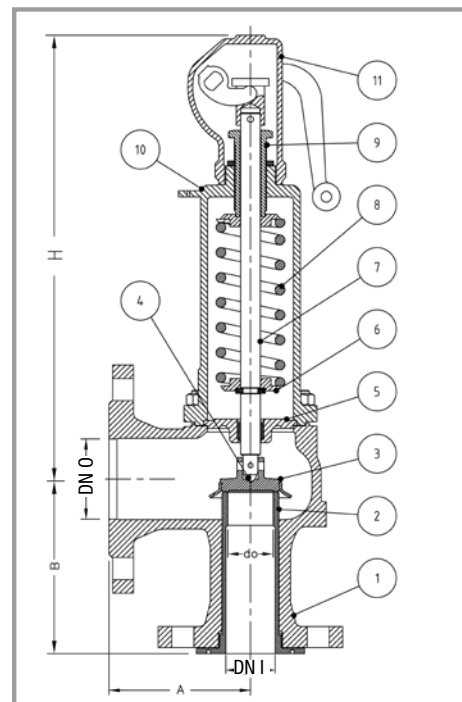

Caps

Tight Cap H4 with packed lifting lever

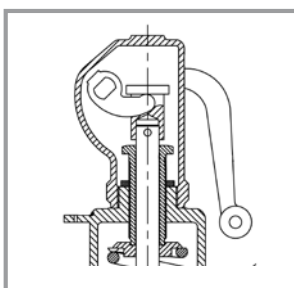

Open Cap H3 with plain lifting lever

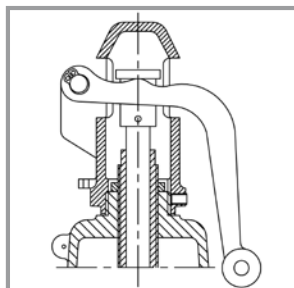

Tight Cap H2 without lifting lever

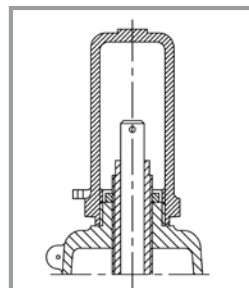

Note

Valves can be manufactured with materials different than those in this table upon request and after Besa Technical Dept. approval.

Valvole di sicurezza Modello 241F-242F

Safety Valves Type 241F-242F

Legenda materiali std.

Descrizione	241F-G / 242F-G Valvola con corpo in ghisa	241F-C / 242F-C Valvola con corpo in acciaio al carbonio	241F-I Valvola con corpo in acciaio inossidabile
1 Corpo Valvola	Ghisa G250	Acciaio al Carbonio ASTM A216 WCB - EN 1.0619	Acciaio inossidabile ASTM A351 CF8M - EN 1.4408
2 Sede	Acciaio inossidabile ASTM 316 - EN 1.4401	Acciaio inossidabile ASTM 316 - EN 1.4401	Acciaio inossidabile ASTM 316 - EN 1.4401
3 Otturatore	Acciaio inossidabile ASTM 420 - EN 1.4028	Acciaio inossidabile ASTM 420 - EN 1.4028	Acciaio inossidabile ASTM 316 - EN 1.4401
4 Sfera	Acciaio inossidabile ASTM 420 - EN 1.4028	Acciaio inossidabile ASTM 420 - EN 1.4028	Acciaio inossidabile ASTM 316 - EN 1.4401
5 Piattello Guida	Ghisa GS450/10 con bussola ASTM 430F Tenifer	Ghisa GS450/10 con bussola ASTM 430F Tenifer o acciaio inossidabile ASTM 316 - EN 1.4401	Acciaio inossidabile ASTM 316 - EN 1.4401
6 Ralla Molla	Acciaio AVP	Acciaio AVP	Acciaio inossidabile ASTM 316 - EN 1.4401
7 Asta	Acciaio inossidabile ASTM 430F - EN 1.4104	Acciaio inossidabile ASTM 430F - EN 1.4104	Acciaio inossidabile ASTM 316 - EN 1.4401
8 Molla	Acciaio al carbonio Acciaio legato	Acciaio al carbonio Acciaio legato	Acciaio inossidabile ASTM 316 S42
9 Vite di regolazione	Ottone OT58/AVP	Ottone OT58/AVP	Acciaio inossidabile ASTM 316 - EN 1.4401 con bussola in PTFE
10 Cappello	Ghisa GS 450/10	Ghisa GS 450/10 o Acciaio al Carbonio ASTM A216 WCB - EN 1.0619	Acciaio inossidabile ASTM A351 CF8M - EN 1.4408
11 Cappuccio H4 a tenuta con leva	Ghisa GS 450/10	Ghisa GS 450/10	Acciaio inossidabile ASTM A351 CF8M - EN 1.4408

Dimensioni caratterizzanti le prestazioni fluidodinamiche

DN E Entrata	do diametro geometrico orifizio	Area geometrica di effluo	DN U Uscita	Alzata otturatore	Max pressione di taratura corpo valvola	
	mm	cm ²		mm	Ghisa barg	Acciaio
1" M	18	2.54	1"1/2 F	5.5	25	40
1"1/4 M	23	4.15	1"1/2 F	6.9	25	40
1"1/2 M	29	6.61	2" F	7.5	25	40
2" M	37	10.75	2"1/2 F	10.2	25	40

M= Filettatura Maschio
F= Filettatura Femmina
GAS UNI 228 O NPT ASME B1.20.1

Dimensioni scartamenti (mm)

241F-G / 242F-G 241F-C / 242F-C /
241F-I

DN E	A	B	A	B	H
1" M	95	67	95	67	215
1"1/4 M	100	84.5	100	84.5	265
1"1/2 M	110	95	110	95	330
2" M	115	116.6	115	116.6	375

dimensioni indicative, da confermare in caso di ordine

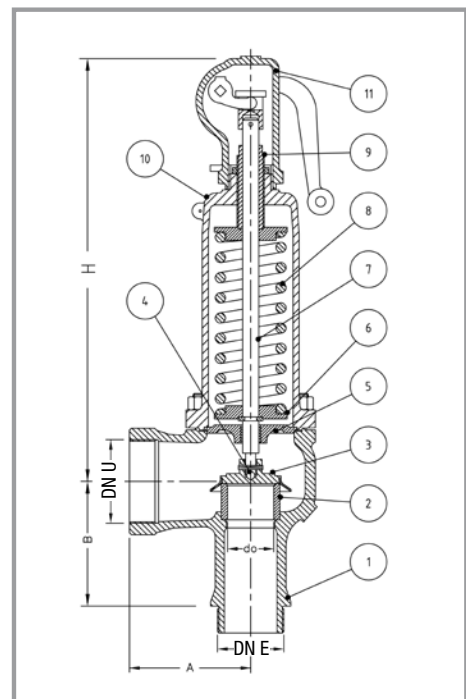

Cappucci

Cappuccio a tenuta con leva di sollevamento dell'otturatore H4

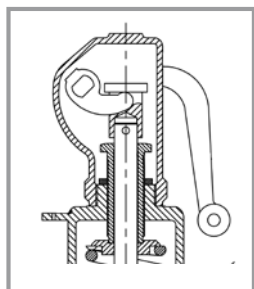

Cappuccio aperto tipo H3 con leva di sollevamento dell'otturatore

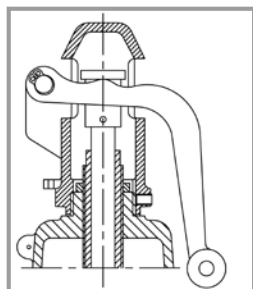

Cappuccio a tenuta tipo H2 senza leva di sollevamento

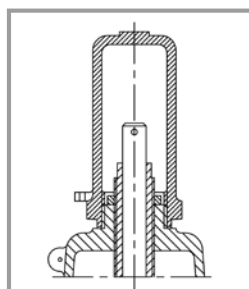

Note

A richiesta e con l'approvazione dell'Ufficio Tecnico, la costruzione delle valvole può essere eseguita utilizzando componenti di materiale diverso da quello indicato nella tabella soprastante.

Valvole di sicurezza Modello 241F-242F
Safety Valves Type 241F-242F

Std. material legenda

Description	241F-G / 242F-G	241F-C / 242F-C	241F-I
	Valve with cast iron body	Valve with carbon steel body	Valve with stainless steel body
1 Valve body	Cast iron G250	Carbon steel ASTM A216 WCB - EN 1.0619	Stainless steel ASTM A351 CF8M - EN 1.4408
2 Seat	Stainless steel ASTM 316 - EN 1.4401	Stainless steel ASTM 316 - EN 1.4401	Stainless steel ASTM 316 - EN 1.4401
3 Disc	Stainless steel ASTM 420 - EN 1.4028	Stainless steel ASTM 420 - EN 1.4028	Stainless steel ASTM 316 - EN 1.4401
4 Ball	Stainless steel ASTM 420 - EN 1.4028	Stainless steel ASTM 420 - EN 1.4028	Stainless steel ASTM 316 - EN 1.4401
5 Guide	Cast iron GS450/10 with bush ASTM 430F Tenifer	Cast iron GS450/10 with bush ASTM 430F Tenifer or stainless steel ASTM 316 - EN 1.4401	Stainless steel ASTM 316 - EN 1.4401
6 Spring plate	AVP Steel	AVP Steel	Stainless steel ASTM 316 - EN 1.4401
7 Spindle	Stainless steel ASTM 430F - EN 1.4104	Stainless steel ASTM 430F - EN 1.4104	Stainless steel ASTM 316 - EN 1.4401
8 Spring	Carbon steel Alloy steel	Carbon steel Alloy steel	Stainless steel ASTM 316 S42
9 Pressure adjusting screw	Brass OT58/AVP steel	Brass OT58/AVP steel	Stainless steel ASTM 316 - EN 1.4401 with bush PTFE
10 Bonnet	Cast iron GS 450/10	Cast iron GS 450/10 or Carbon steel ASTM A216 WCB - EN 1.0619	Stainless steel ASTM A351 CF8M - EN 1.4408
11 Tight cap H4 with lifting lever	Cast iron GS 450/10	Cast iron GS 450/10	Stainless steel ASTM A351 CF8M - EN 1.4408

Dimensions defining valve performances

DN I Inlet	Actual orifice diameter	Actual discharge area	DN O Outlet	Disc lift	Max set pressure valve body	
	mm	cm ²			Cast iron barg	Steel
1" M	18	2.54	1"1/2 F	5.5	25	40
1"1/4 M	23	4.15	1"1/2 F	6.9	25	40
1"1/2 M	29	6.61	2" F	7.5	25	40
2" M	37	10.75	2"1/2 F	10.2	25	40

M= Male threading
 F= Female threading
 GAS UNI 228 O NPT ASME B1.20.1

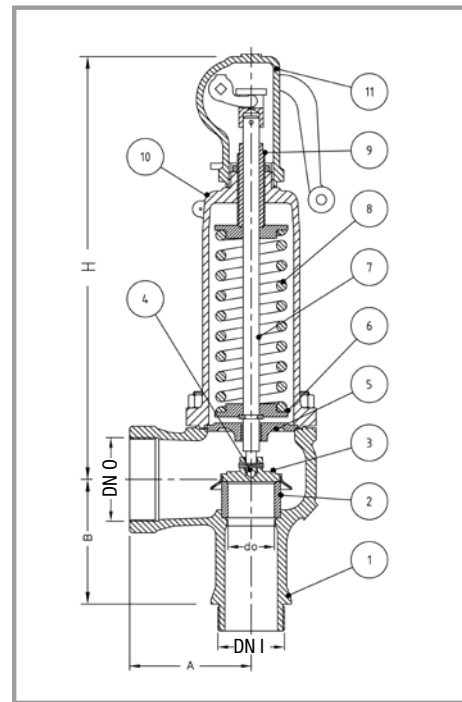

Center to face dimensions (mm)

DN I	241F-G / 242F-G		241F-C / 242F-C / 241F-I		H
	A	B	A	B	
1" M	95	67	95	67	215
1"1/4 M	100	84.5	100	84.5	265
1"1/2 M	110	95	110	95	330
2" M	115	116.6	115	116.6	375

approximate dimensions to be confirmed at order

Caps

Tight Cap H4 with packed lifting lever Open Cap H3 with plain lifting lever Tight Cap H2 without lifting lever

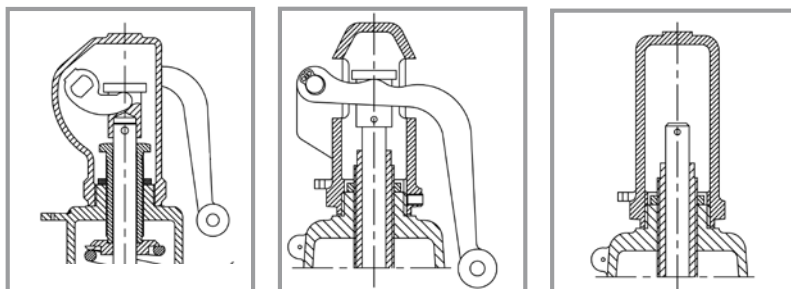

Note

Valves can be manufactured with materials different than those in this table upon request and after Besa Technical Dept. approval.

Valvole di sicurezza Modello 241bF-242bF

Safety Valves Type 241bF-242bF

Legenda materiali std.

Descrizione	241bF-C / 242bF-C	241bF-I
	Valvola con corpo in acciaio al carbonio	Valvola con corpo in acciaio inossidabile
1 Corpo Valvola	Acciaio al carbonio ASTM A216 WCB - EN 1.0619	Acciaio inossidabile ASTM A351 CF8M - EN 1.4408
2 Boccaglio	Acciaio inossidabile ASTM 316 - EN 1.4401	Acciaio inossidabile ASTM 316 - EN 1.4401
3 Otturatore	Acciaio inossidabile ASTM 420 - EN 1.4028	Acciaio inossidabile ASTM 316 - EN 1.4401
4 Sfera	Acciaio inossidabile ASTM 420 - EN 1.4028	Acciaio inossidabile ASTM 316 - EN 1.4401
5 Piattello guida	Ghisa GS450/10 Con bussola ASTM 430F Tenifer o acciaio inossidabile ASTM 316 - EN 1.4401	Acciaio inossidabile ASTM 316 - EN 1.4401
6 Ralla molla	Acciaio AVP	Acciaio inossidabile ASTM 316 - EN 1.4401
7 Asta	Acciaio inossidabile ASTM 430F - EN 1.4104	Acciaio inossidabile ASTM 316 - EN 1.4401
8 Molla	Acciaio al carbonio Acciaio legato	Acciaio inossidabile ASTM 316 S42
9 Vite di regolazione	Ottone OT58 /AVP	Acciaio inossidabile ASTM 316 - EN 1.4401 / con bussola in PTFE
10 Cappello	Ghisa GS 450/01 o acciaio al carbonio ASTM A216 WCB - EN 1.0619	Acciaio inossidabile ASTM A351 CF8M - EN 1.4408
11 Cappuccio H4 a tenuta con leva	Ghisa GS 450/10	Acciaio inossidabile ASTM A351 CF8M - EN 1.4408

Dimensioni caratterizzanti le prestazioni fluidodinamiche

DN E Entrata	do diametro geometrico orifizio mm	Area geometrica di efflusso cm ²	DN U Uscita	Alzata otturatore mm	Max pressione di taratura barg
1" M	18	2.54	1"1/2 F	5.5	40
1"1/4 M	23	4.15	1"1/2 F	6.9	40
1"1/2 M	29	6.61	2" F	7.5	40
2" M	37	10.75	2"1/2 F	10.2	40

M= Filettatura Maschio
F= Filettatura Femmina
GAS UNI 228 O NPT ASME B1.20.1

Dimensioni scartamenti (mm)

241bF-C / 242bF-C /
241bF-I

DN E	A	B	H
1" M	95	67	215
1"1/4 M	100	84.5	265
1"1/2 M	110	95	330
2" M	115	116.6	375

dimensioni indicative, da confermare in caso di ordine

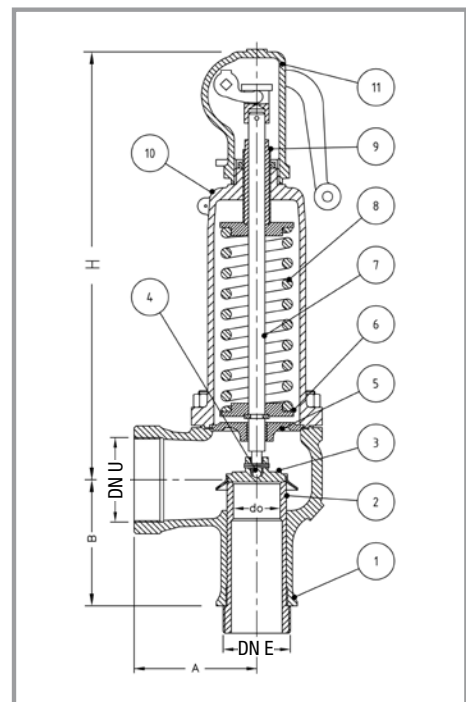

Cappucci

Cappuccio a tenuta con leva di sollevamento dell'otturatore H4

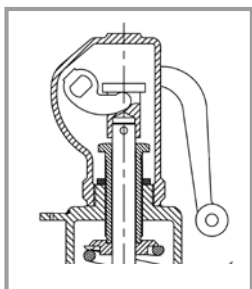

Cappuccio aperto tipo H3 con leva di sollevamento dell'otturatore

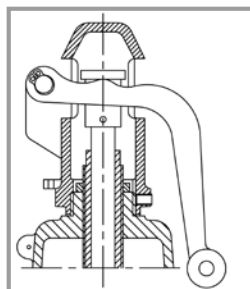

Cappuccio a tenuta tipo H2 senza leva di sollevamento

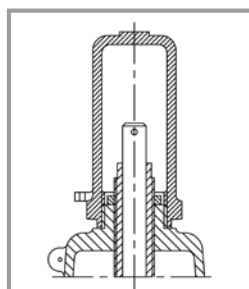

Note

A richiesta e con l'approvazione dell'Ufficio Tecnico, la costruzione delle valvole può essere eseguita utilizzando componenti di materiale diverso da quello indicato nella tabella soprastante.

Valvole di sicurezza Modello 241b-242b
Safety Valves Type 241b-242b

Std. material legenda

Description	241bF-C / 242bF-C	241bF-I
	Valve with carbon steel body	Valve with stainless steel body
1 Valve body	Carbon steel ASTM A216 WCB - EN 1.0619	Stainless steel ASTM A351 CF8M - EN 1.4408
2 Full nozzle (seat)	Stainless steel ASTM 316 - EN 1.4401	Stainless steel ASTM 316 - EN 1.4401
3 Disc	Stainless steel ASTM 420 - EN 1.4028	Stainless steel ASTM 316 - EN 1.4401
4 Ball	Stainless steel ASTM 420 - EN 1.4028	Stainless steel ASTM 316 - EN 1.4401
5 Guide	Cast iron GS450/10 with bush ASTM 430F Tenifer or stainless steel ASTM 316 - EN 1.4401	Stainless steel ASTM 316 - EN 1.4401
6 Spring plate	AVP Steel	Stainless steel ASTM 316 - EN 1.4401
7 Spindle	Stainless steel ASTM 430F - EN 1.4104	Stainless steel ASTM 316 - EN 1.4401
8 Spring	Carbon steel Alloy steel	Stainless steel ASTM 316 S42
9 Pressure adjusting screw	Brass OT58 /AVP steel	Stainless steel ASTM 316 - EN 1.4401 / with bush in PTFE
10 Bonnet	Cast iron GS 450/01 or Carbon steel ASTM A216 WCB - EN 1.0619	Stainless steel ASTM A351 CF8M - EN 1.4408
11 Tight cap H4 with lifting lever	Cast iron GS 450/10	Stainless steel ASTM A351 CF8M - EN 1.4408

Dimensions defining valve performances

DN I Inlet	Actual orifice diameter mm	Actual discharge area cm ²	DN O Outlet	Disc lift h mm.	Max set pressure barg
1" M	18	2.54	1"1/2 F	5.5	40
1"1/4 M	23	4.15	1"1/2 F	6.9	40
1"1/2 M	29	6.61	2" F	7.5	40
2" M	37	10.75	2"1/2 F	10.2	40

M= Male threading
F= Female threading
GAS UNI 228 O NPT ASME B1.20.1

Center to face dimensions (mm)

241bF-C / 242bF-C /
241bF-I

DN I	A	B	H
1" M	95	67	215
1"1/4 M	100	84.5	265
1"1/2 M	110	95	330
2" M	115	116.6	375

approximate dimensions to be confirmed at order

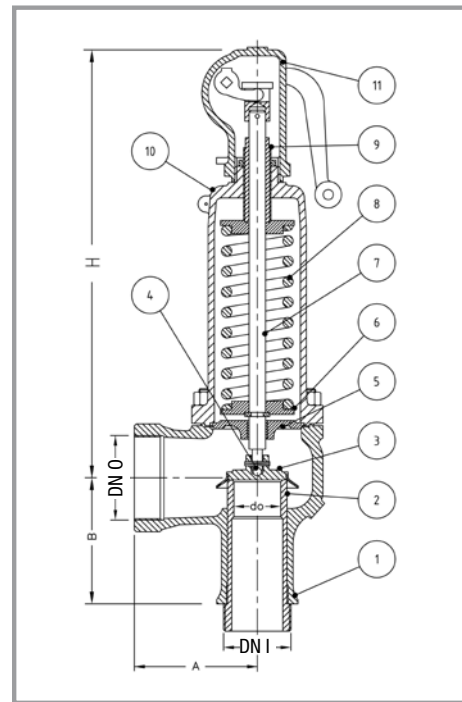

Caps

Tight Cap H4 with packed lifting lever

Open Cap H3 with plain lifting lever

Tight Cap H2 without lifting lever

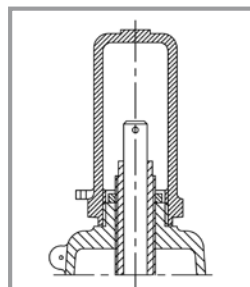
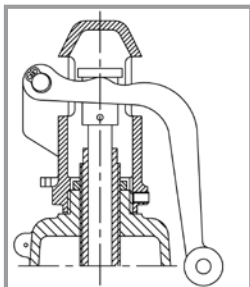
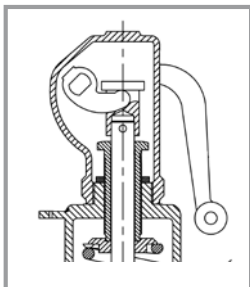

Note

Valves can be manufactured with materials different than those in this table upon request and after Besa Technical Dept. approval.

Valvole di sicurezza Modello 241T-241bT

Safety Valves Type 241T-241bT

Legenda materiali std.

Descrizione	241T-C / 241bT-C	241T-I - 241bT-I
	Corpo in acciaio al carbonio	Corpo in acciaio inossidabile
1 Corpo Valvola mod. 241T	Acciaio al carbonio ASTM A216 WCB - EN 1.0619 rivestito in materiale termoplastico	Acciaio inossidabile ASTM A351 CF8M - EN 1.4408 rivestito in materiale termoplastico
Corpo Valvola mod. 241bT	Acciaio al carbonio ASTM A216 WCB - EN 1.0619	Acciaio inossidabile ASTM A351 CF8M - EN 1.4408
2 Sede rivestita (241T)	ASTM 316 - EN 1.4401 rivestito in materiale termoplastico	
Boccaglio (241bT)	PTFE	
3 Soffietto	PTFE	
4 Disco otturatore	Acciaio inossidabile Vetro temperato - PTFE - Hastelloy	Acciaio inossidabile Vetro temperato - PTFE - Hastelloy
5 Piattello guida	Ghisa GS450/10 Con bussola ASTM 430F Tenifer o acciaio inossidabile ASTM 316 - EN 1.4401	Acciaio inossidabile ASTM 316 - EN 1.4401
6 Ralla	Acciaio AVP	Acciaio inossidabile ASTM 316 - EN 1.4401
7 Asta	Acciaio inossidabile ASTM 430F - EN 1.4104	Acciaio inossidabile ASTM 316 - EN 1.4401
8 Molla	Acciaio al carbonio Acciaio legato	Acciaio inossidabile ASTM 316 S42
9 Vite di regolazione	Ottone OT58 /Avp	Acciaio inossidabile ASTM 316 - EN 1.4401 / con bussola in PTFE
10 Cappello	Ghisa GS 450/01 o acciaio al carbonio ASTM A216 WCB - EN 1.0619	Acciaio inossidabile ASTM A351 CF8M - EN 1.4408
11 Cappuccio H4 a tenuta con leva	Ghisa GS 450/10	Acciaio inossidabile ASTM A351 CF8M - EN 1.4408

Dimensioni caratterizzanti le prestazioni fluidodinamiche

DN E Entrata	do diametro geometrico orifizio	Area geometrica di efflusso cm ²	DN U Uscita	Alzata otturatore mm	Max pressione di taratura barg
(1) 20-3/4"	18	2.54	40-1"1/2	5.5	10
25-1"	23	4.15	40-1"1/2	6.9	10
32-1"1/4	29	6.61	50-2"	7.5	10
40-1"1/2	37	10.75	65-2"1/2	10.2	10
50-2"	46	16.62	80-3"	13.5	10
65-2"1/2	60	28.27	100-4"	17.0	10
80-3"	74	43.00	125-5"	21.5	10
100-4"	92	66.48	150-6"	27.6	10
125-5"	98	75.43	200-8"	29.4	10
150-6"	125	122.72	250-10"	37.5	10

(1) solo modello 241bT

Dimensioni scartamenti (mm)

DN E	241bT / 241T		FLANGE		H
	A	B	ANSI/ASME	CL150/CL150	
20	95	85	94.5	82.9	215
25	100	105	99.5	104.5	265
32	110	115	109	116	330
40	117	140	117.2	142.6	375
50	120	150	121.3	151.2	420
65	136	172	139.8	175.4	525
80	173	197	157.8	201.6	600
100	188	220	179.4	227.7	655
125	198	246	202.6	254.9	655
150	216	288	223.2	296.5	780

dimensioni indicative, da confermare in caso di ordine

Cappucci

Cappuccio a tenuta tipo H4 a tenuta con leva

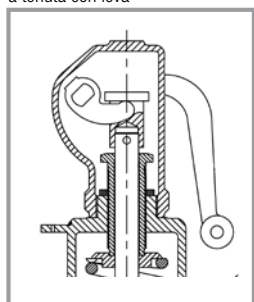

Cappuccio H2 a tenuta senza leva

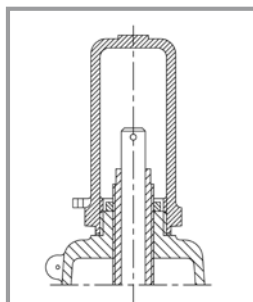

Note

A richiesta e con l'approvazione dell'Ufficio Tecnico, la costruzione delle valvole può essere eseguita utilizzando componenti di materiale diverso da quello indicato nella tabella soprastante.

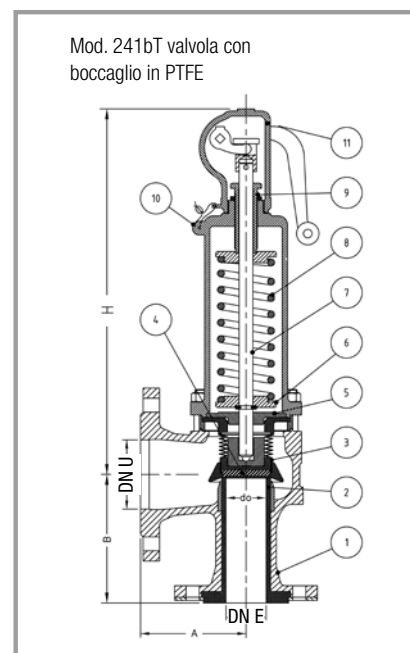
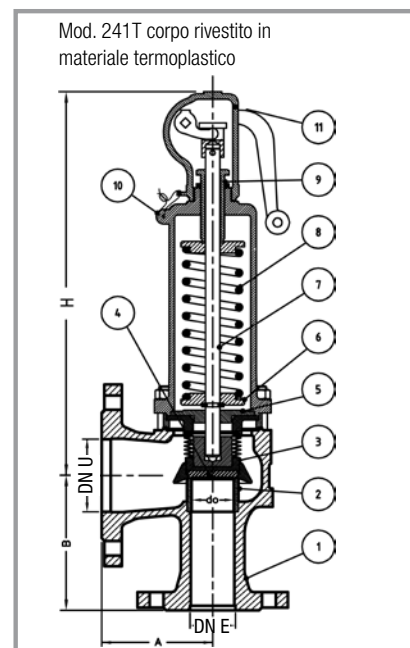

Valvole di sicurezza Modello 241T-241bT
Safety Valves Type 241T-241bT

Std. material legenda

Description	241T-C / 241bT-C Valve with lined carbon steel body	241T-I - 241bT-I Valve with lined stainless steel body
1 Valve body 241T	Carbon steel ASTM A216 WCB - EN 1.0619 lined with thermoplastic material	Stainless steel ASTM A351 CF8M - EN 1.4408 lined with thermoplastic material
Valve body 241bT	Carbon steel ASTM A216 WCB - EN 1.0619	Stainless steel ASTM A351 CF8M - EN 1.4408
2 Lined seat (241T) Full nozzle (241bT)	ASTM 316 - EN 1.4401 lined with thermoplastic material PTFE	
3 Bellow	PTFE	PTFE
4 Disc	Stainless steel tempered glass - PTFE - Hastelloy	Stainless steel tempered glass - PTFE - Hastelloy
5 Guide	Cast iron GS450/10 with bush ASTM 430F Tenifer or stainless steel ASTM 316 - EN 1.4401	Stainless steel ASTM 316 - EN 1.4401
6 Spring plate	AVP Steel	Stainless steel ASTM 316 - EN 1.4401
7 Spindle	Stainless steel ASTM 430F - EN 1.4104	Stainless steel ASTM 316 - EN 1.4401
8 Spring	Carbon steel Alloy steel	Stainless steel ASTM 316 S42
9 Pressure adjusting screw	Brass OT58 /AVP steel	Stainless steel ASTM 316 - EN 1.4401 / with bush in PTFE
10 Bonnet	Cast iron GS 450/01 o Carbon steel ASTM A216 WCB - EN 1.0619	Stainless steel ASTM A351 CF8M - EN 1.4408
11 Tight cap H4 with lifting lever	Cast iron GS 450/10	Stainless steel ASTM A351 CF8M - EN 1.4408

Dimensions defining valve performances

DN I Inlet	Actual orifice diameter mm	Actual discharge area cm ²	DN O Outlet mm	Disc lift h mm.	Max set pressure barg
(1) 20-3/4"	18	2.54	40-1"1/2	5.5	40
25-1"	23	4.15	40-1"1/2	6.9	10
32-1"1/4	29	6.61	50-2"	7.5	10
40-1"1/2	37	10.75	65-2"1/2	10.2	10
50-2"	46	16.62	80-3"	13.5	10
65-2"1/2	60	28.27	100-4"	17.0	10
80-3"	74	43.00	125-5"	21.5	10
100-4"	92	66.48	150-6"	27.6	10
125-5"	98	75.43	200-8"	29.4	10
150-6"	125	122.72	250-10"	37.5	10

(1) only type 241bT

Center to face dimensions (mm)

241bT / 241T

EN FLANGE
PN16/PN16
PN25/PN16
PN40/PN16

ANSI/ASME
FLANGE
CL150/CL150
CL 300/CL150

DN I	A	B	A	B	H
20	95	85	94.5	82.9	215
25	100	105	99.5	104.5	265
32	110	115	109	116	330
40	117	140	117.2	142.6	375
50	120	150	121.3	151.2	420
65	136	172	139.8	175.4	525
80	173	197	157.8	201.6	600
100	188	220	179.4	227.7	655
125	198	246	202.6	254.9	655
150	216	288	223.2	296.5	780

approximate dimensions to be confirmed at order

Caps

Tigh Cap H4 with packed lifting lever

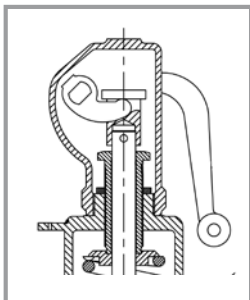

Tight Cap H2 without lifting lever

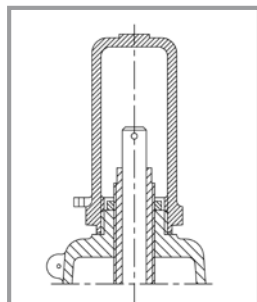

Note

Valves can be manufactured with materials different than those in this table upon request and after Besa Technical Dept. approval.

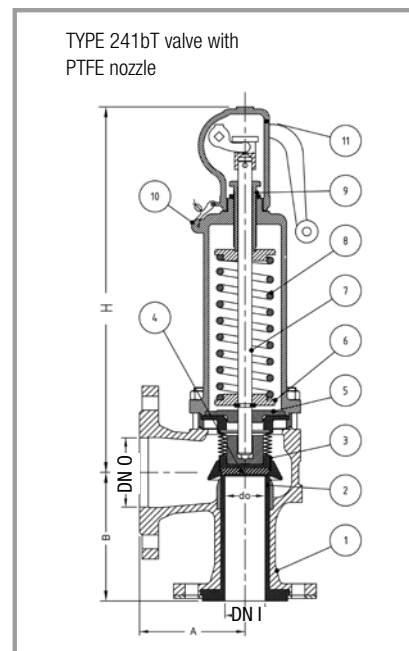
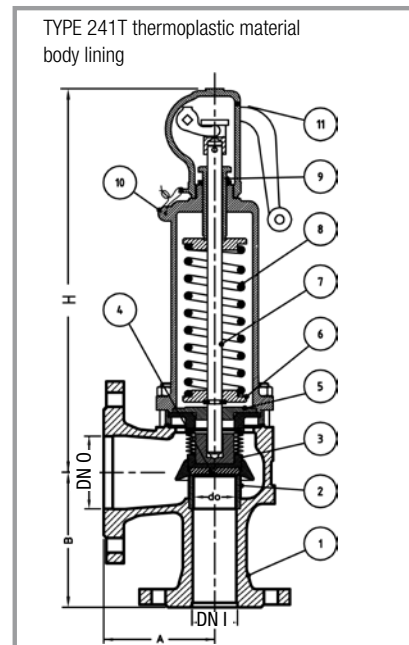

Tabella delle Portate / Flow rate table

Pressione di taratura P / Set pressure P	DN 20 - do 18 mm			DN 25 - do 23 mm			DN 32 - do 29 mm			DN 40 - do 37 mm			DN 50 - do 46 mm			DN 65 - do 60 mm		
	acqua/water	aria/air	vapore d'acqua sat./sat. steam	acqua/water	aria/air	vapore d'acqua sat./sat. steam	acqua/water	aria/air	vapore d'acqua sat./sat. steam	acqua/water	aria/air	vapore d'acqua sat./sat. steam	acqua/water	aria/air	vapore d'acqua sat./sat. steam	acqua/water	aria/air	vapore d'acqua sat./sat. steam
	a 25°C	a 25°C	a 25°C	a 25°C	a 25°C	a 25°C	a 25°C	a 25°C	a 25°C	a 25°C	a 25°C	a 25°C	a 25°C	a 25°C	a 25°C	a 25°C	a 25°C	a 25°C
bar	kg/h	kg/h	kg/h	kg/h	kg/h	kg/h	kg/h	kg/h	kg/h	kg/h	kg/h	kg/h	kg/h	kg/h	kg/h	kg/h	kg/h	kg/h
0,25	3.822	145	94	6.241	242	156	9.922	371	239	16.152	583	376	24.965	884	570	42.474	1.447	933
0,5	5.005	196	123	8.173	331	208	12.993	509	319	21.151	814	511	32.692	1.236	776	55.620	2.029	1.274
0,75	5.958	243	153	9.728	410	259	15.466	632	399	25.176	1.012	639	38.914	1.564	988	66.206	2.573	1.624
1	6.778	290	185	11.067	488	312	17.595	752	481	28.641	1.206	772	44.270	1.835	1.174	75.318	3.122	1.998
1,5	8.302	382	241	13.555	643	405	21.550	993	625	35.080	1.641	1.033	54.222	2.500	1.574	92.249	4.190	2.638
2	9.587	475	300	15.652	788	498	24.884	1.235	781	40.508	2.039	1.252	62.611	3.107	1.965	106.522	5.286	3.343
2,5	10.718	565	355	17.500	936	589	27.822	1.488	936	45.290	2.423	1.524	70.002	3.745	2.356	119.097	6.283	3.952
3	11.741	657	412	19.171	1.088	683	30.478	1.730	1.086	49.613	2.817	1.768	76.685	4.355	2.733	130.466	7.409	4.650
4	13.558	837	522	22.137	1.367	865	35.193	2.173	1.356	57.289	3.587	2.238	88.549	5.544	3.460	150.651	9.433	5.886
5	15.159	1.022	634	24.750	1.668	1.036	39.348	2.653	1.647	64.052	4.318	2.682	99.002	6.675	4.146	168.435	11.357	7.053
6	16.606	1.195	739	27.113	1.951	1.207	43.104	3.103	1.918	70.166	5.051	3.123	108.452	7.807	4.828	184.513	13.282	8.214
7	17.936	1.368	843	29.285	2.235	1.377	46.558	3.553	2.189	75.788	5.784	3.564	117.143	8.940	5.508	199.298	15.210	9.372
8	19.175	1.542	947	31.308	2.518	1.546	49.773	4.004	2.459	81.022	6.518	4.003	125.232	10.075	6.187	213.060	17.140	10.527
9	20.338	1.716	1.051	33.207	2.802	1.716	52.792	4.455	2.728	85.937	7.253	4.441	132.829	11.210	6.865	225.986	19.073	11.680
10	21.439	1.890	1.154	35.003	3.086	1.885	55.648	4.907	2.997	90.586	7.988	4.879	140.015	12.347	7.542	238.211	21.007	12.831
12	23.485	2.239	1.360	38.345	3.656	2.221	60.960	5.812	3.531	99.233	9.462	5.748	153.380	14.625	8.885	260.950	24.882	15.117
14	25.367	2.589	1.566	41.418	4.227	2.557	65.846	6.720	4.065	107.185	10.939	6.617	165.672	16.908	10.228	281.861	28.767	17.402
16	27.119	2.939	1.771	44.278	4.799	2.892	70.393	7.629	4.599	114.587	12.419	7.486	177.112	19.196	11.571	301.326	32.659	19.686
18	28.764	3.290	1.977	46.964	5.372	3.229	74.663	8.541	5.133	121.539	13.903	8.357	187.858	21.489	12.917	319.607	36.561	21.976
20	30.320	3.642	2.183	49.505	5.947	3.565	78.703	9.454	5.667	128.115	15.390	9.226	198.021	23.788	14.260	336.899	40.471	24.261
22	31.801	3.995	2.387	51.922	6.522	3.897	82.545	10.369	6.196	134.369	16.880	10.086	207.689	26.091	15.590	353.346	44.389	26.523
24	33.215	4.348	2.593	54.231	7.099	4.232	86.216	11.287	6.730	140.346	18.373	10.956	216.926	28.399	16.935	369.061	48.317	28.812
26	34.572	4.702	2.799	56.446	7.678	4.571	89.378	12.206	7.267	146.078	19.870	11.829	225.786	30.713	18.284	384.135	52.252	31.108
28	35.877	5.057	3.006	58.577	8.257	4.909	93.126	13.128	7.805	151.593	21.370	12.705	234.311	33.031	19.638	398.639	56.197	33.411
30	37.137	5.413	3.213	60.634	8.838	5.245	96.396	14.051	8.339	156.916	22.873	13.575	242.537	35.354	20.983	412.635	60.149	35.700
32	38.355	5.769	3.419	62.623	9.420	5.582	99.558	14.976	8.875	162.063	24.379	14.447	250.494	37.682	22.330	426.171	64.110	37.991
34	39.536	6.127	3.625	64.551	10.003	5.919	102.623	15.904	9.410	167.053	25.889	15.318	258.206	40.015	23.677	439.292	68.080	40.283
36	40.682	6.485	3.830	66.423	10.588	6.254	105.599	16.833	9.943	171.897	27.401	16.185	265.694	42.353	25.017	452.032	72.057	42.563
38	41.798	6.843	4.038	68.244	11.174	6.593	108.494	17.764	10.482	176.609	28.917	17.063	272.977	44.696	26.374	464.423	76.043	44.872
40	42.884	7.203	4.246	70.017	11.761	6.934	111.313	18.697	11.023	181.199	30.436	17.944	280.071	47.044	27.736	476.492	80.037	47.188

Pressione di taratura P / Set pressure P	DN 80 - do 74 mm			DN 100 - do 92 mm			DN 125 - do 98 mm			DN 150 - do 125 mm			DN 200 - do 165 mm			DN 250 - do 200 mm		
	acqua/water	aria/air	vapore d'acqua sat./sat. steam	acqua/water	aria/air	vapore d'acqua sat./sat. steam	acqua/water	aria/air	vapore d'acqua sat./sat. steam	acqua/water	aria/air	vapore d'acqua sat./sat. steam	acqua/water	aria/air	vapore d'acqua sat./sat. steam	acqua/water	aria/air	vapore d'acqua sat./sat. steam
	a 25°C	a 25°C	a 25°C	a 25°C	a 25°C	a 25°C	a 25°C	a 25°C	a 25°C	a 25°C	a 25°C	a 25°C	a 25°C	a 25°C	a 25°C	a 25°C	a 25°C	a 25°C
bar	kg/h	kg/h	kg/h	kg/h	kg/h	kg/h	kg/h	kg/h	kg/h	kg/h	kg/h	kg/h	kg/h	kg/h	kg/h	kg/h	kg/h	kg/h
0,25	64.608	2.289	1.477	99.862	3.810	2.458	113.313	4.246	2.740	184.352	6.909	4.458	321.215	12.257	7.909	471.941	17.688	11.413
0,5	84.605	3.201	2.010	130.770	5.124	3.218	148.384	5.814	3.651	241.410	9.460	5.941	420.632	16.483	10.351	618.009	24.217	15.209
0,75	100.706	4.049	2.556	155.658	6.468	4.083	176.623	7.339	4.633	287.353	11.747	7.417	500.684	20.804	13.136	735.624	30.074	18.988
1	114.567	4.825	3.089	177.081	7.695	4.926	200.932	8.732	5.590	326.902	13.988	8.954	569.594	24.373	15.602	836.870	35.810	22.924
1,5	140.321	6.566	4.135	216.888	10.149	6.391	246.100	11.516	7.252	400.388	18.736	11.799	697.636	32.647	20.558	1.024.993	47.966	30.205
2	162.032	8.274	5.233	250.446	12.609	7.974	284.178	14.308	9.048	462.338	23.278	14.721	805.577	40.560	25.650	1.183.585	59.592	37.686
2,5	181.160	9.830	6.183	280.011	15.194	9.557	317.726	17.001	10.694	516.916	27.660	17.399	900.675	48.195	30.316	1.323.307	70.810	44.541
3	198.453	11.427	7.171	306.740	17.420	10.932	348.054	19.766	12.405	566.259	32.158	20.182	986.650	56.033	35.165	1.449.624	82.326	51.666
4	229.157	14.349	8.954	354.198	22.179	13.840	401.904	25.166	15.705	653.869	40.944	25.550	1.139.302	70.364	44.519	1.673.905	103.382	64.514
5	256.208	17.275	10.729	396.009	26.702	16.584	449.347	30.298	18.817	731.055	49.293	30.615	1.273.791	85.888	53.344	1.871.502	126.190	78.375
6	280.664	20.204	12.494	433.810	31.229	19.312	492.239	35.435	21.914	800.838	57.651	35.652	1.395.380	100.451	62.121	2.050.145	147.587	91.270
7	303.154	23.137	14.256	468.572	35.762	22.035	531.683	40.578	25.003	865.010	66.019	40.679	1.507.194	115.031	70.879	2.214.426	169.008	104.139
8	324.088	26.073	16.013	500.928	40.300	24.751	568.397	45.727	28.085	924.741	74.396	45.693	1.611.268	129.627	79.615	2.367.337	190.453	116.974
9	343.749	29.012	17.767	531.318	44.842	27.462	602.880	50.882	31.161	980.842	82.782	50.696	1.709.019	144.240	88.334	2.510.955	211.923	129.783
10	362.346	31.954	19.518	560.061	49.391	30.168	635.495	56.043	34.231	1.033.904	91.178	55.692	1.801.474	158.869	97.039	2.646.795	233.416	142.573
12	396.934	37.849	22.995	613.523	58.502	35.542	696.158	66.382	40.329	1.132.598	107.998	65.613	1.973.438	188.177	114.325	2.899.450	276.476	167.970
14	428.743	43.757	26.471	662.688	67.634	40.915	751.944	76.743	46.426	1.223.358	124.856	75.532	2.131.579	217.550	131.606	3.131.797	319.633	193.361
16	458.350	49.679	29.945	708.450	76.786	46.285	803.870	87.12										